

4 Channels DALI DT8 Dimmer with Built-in Master Function

09.2309OLED.04372



Important: Read All Instructions Prior to Installation

Function introduction

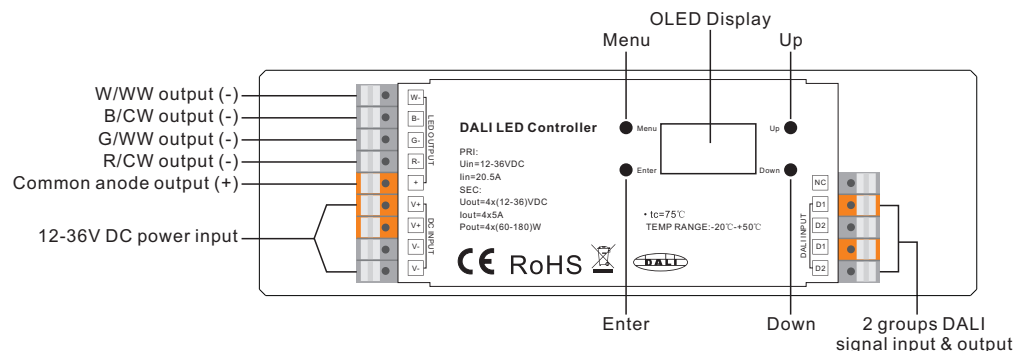

Product Data

No.	Input Voltage	Output Current	Output Power	DALI Consumption	Remarks	Size(LxWxH)	Ambient Temperature
1	12-36VDC	4x5A	4x(60-180)W	2mA	Constant voltage	170x53.4x28mm	-20°C ~ +50°C
2	12-48VDC	4x350mA	4x(4.2-16.8)W	2mA	Constant current	170x53.4x28mm	
3	12-48VDC	4x700mA	4x(8.4-33.6)W	2mA	Constant current	170x53.4x28mm	

- DALI DT8 dimmer, 4 channels PWM output, built-in DALI master function
- OLED display interface , easy & fast installation
- No DALI master required for configuration
- Cost & time saving than DALI USB configuration
- DT8 colour types all in one: XY, Tc, RGBWA, XY+Tc and RGB+Tc settable
- Each device is controlled via a single DALI address
- Enable to address and group the DT8 device
- Enable to predefine & recall 16 scenes for the DT8 device
- 250Hz/500Hz/1500Hz PWM frequency settable, smooth and fine DT8 colour control
- Enables to set a min. level for dimming between this level to max. level
- Enable to set output level and manual control (stand-alone)
- Enables to set fade time, fade rate, power on level, system failure level
- Compatible with universal DALI masters that supports DT8 commands.
- Complies to IEC 62386-209: 2011

Safety & Warnings

- DO NOT install with power applied to device.
- DO NOT expose the device to moisture.

Commissioning and Configuration

Menu Select

After wiring the dimmer correctly, power on it, the OLED will show ,



A-00 means the DALI address assigned to the device by factory default is 00, and Tc colour means factory default colour type is Tc. Then click “Menu” button to enter Menu Select interface, keep clicking “Down” buttons, you will get commissioning and configuration options one by one on the OLED display as follows:

- 1.Set Addr: assign DALI a address to the device
- 2.Set Group: assign the device to one or more DALI groups
- 3.Save Scene: configure up to 16 scenes (0–15) to the device
- 4.Go to Scene: recall the configured 16 scenes
- 5.Set Out level: set out level of the device manually
- 6.Set Time Rate: set fade time and fade rate
- 7.Set Power Min: set a minimum level, the dimmer can not be dimmed below this value
- 8.Set Power on: set a level as the value after power is restored
- 9.Set Sys fail: set a level as the value in the event of failure of the DALI power supply
- 10.Colour type: set DT8 colour type, Tc, XY, RGBWA, XY+Tc and RGB+Tc settable

When set colour type as XY, next options are as follows:

- 11.Set Zero Addr: set the starting DALI address as 0/1
- 12.Set PWM freq: set the output PWM frequency
- 13.Reset: factory reset the dimmer

When set colour type as RGBWA, next options are as follows:

- 11.Set Channel: set number of RGBWA channels, 3 (RGB)/4 (RGBW)/5 (RGBWA) settable
- 12.Set Zero Addr: set the starting DALI address as 0/1
- 13.Set PWM freq: set the output PWM frequency
- 14.Reset: factory reset the dimmer

When set colour type as Tc, XY+Tc or RGB+Tc, next options are as follows:

- 11.Set wm cl ph: set a physical lower limit and a physical upper limit for colour temperature of the device
- 12.Set wm cl tc: set colour temperature range in which the colour temperature of the device can be changed. The colour temperature range is restricted to the physical upper and lower limits.

13. Set Zero Addr: set the starting DALI address as 0/1

14. Set PWM freq: set the output PWM frequency

15. Reset: factory reset the dimmer

Colour type

Before commissioning and configuration, please first set DT8 colour type for the device according to the LED light to be controlled and colour types that your DALI master controller supports:

1) Click "Down" button on Menu select interface to select "10. Colour type"



2) Click "Enter" button to enter set colour type interface, click "Enter" button move the cursor to the digit after "Type:", then click "Up" and "Down" buttons to select 0/1/2/3/4, then click "Enter" button to confirm setting, factory default is 1 (Tc).

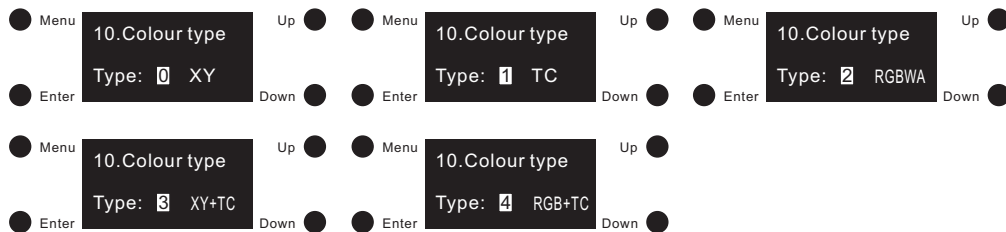

Note:

- When set colour type as XY, the device will control RGB LED light.
- When set colour type as Tc, the device will control tunable white LED light.
- When set colour type as RGBWA, the device will control RGB (number of channel as 3)/RGBW (number of channel as 4)/RGBW+Amber (number of channel as 5) LED lights.
- When set colour type as XY+Tc, the device will control RGB and tunable white LED lights together.
- When set colour type as RGB+Tc, the device will control RGB and tunable white LED lights together.

Set Channel (For colour type RGBWA only)

This configuration is to set number of RGBWA channels before configuring this colour type, 3 (RGB)/4 (RGBW)/5 (RGBWA) can be settable.

1) Once set colour type as RGBWA, click "Menu" button to return to Menu select interface, click "Down" button to select "11. set Channel".

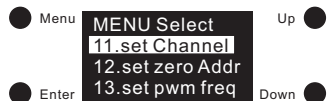

2) Click "Enter" button to enter set channel interface, then click "Enter" button to move the cursor to the digit after "Total ch:", click "Up" and "Down" to select 3/4/5, then click "Enter" to confirm setting and the cursor will move to "Total ch:".

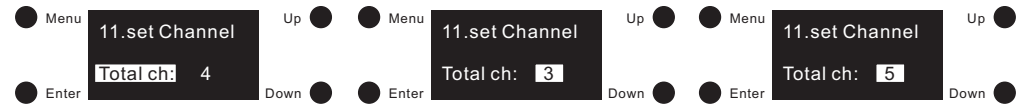

Note:

- 3 channels means RGB, 4 channels means RGBW, and 5 channels means RGBW+Amber.
- By factory default, the number of RGBWA channel is 4 RGBW.

Set zero Addr

This configuration is to set the starting DALI address according to different DALI systems:

3) Click "Menu" button to return to Menu select interface, click "Down" button to select "set zero Addr"

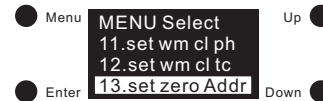

4) Click "Enter" button to enter set zero address interface, then click "Enter" button to move the cursor to the digit "0" after "zero Addr:", click "Up" and "Down" to select 0/1, then click "Enter" to confirm setting and the cursor will move to "zero Addr:".

0 means starting DALI address is 00, and DALI address range will be 00-63.

1 means starting DALI address is 01, and DALI address range will be 01-64.

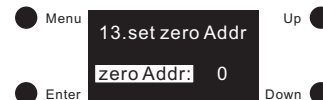

Note:

- By factory default, the starting DALI address is 00.

Set Addr

1) Once colour type is set, click "Menu" button to return to Menu select interface, click "Up" and "Down" buttons to select "1. set Addr"

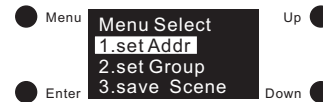

2) Click "Enter" button to enter set address interface. Click "Enter" button move the cursor to the 1st digit after "Addr 1:", then click "Up" and "Down" buttons to select a digit, then click "Enter" to confirm and move the cursor to the 2nd digit and set it, then click "Enter" button to confirm setting, and the cursor will be moved to Addr 1.

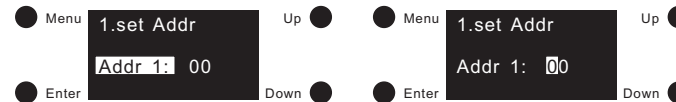

Note:

DALI address is settable from 00-63-FF, and factory default DALI address for the device is 00. FF means no address assigned.

Set Group

1)Click "Menu" button to return to Menu select interface, click "Down" button to select "2. set Group"



2)Click "Enter" button to enter set group interface, the device can be assigned to total 16 groups (G0-G15). Click "Enter" to move the cursor to the digit after "G0:", click "Up" and "Down" to select 0/1, 0 means the device does not belong to this group, and 1 means it belongs to the group, then click "Enter" button to confirm setting and move the cursor to "G0".

3)Click "Down" button to move the cursor to G1-G15 and set other groups.



Note:

The device can be assigned to total 16 groups (G0-G15). By factory default it does not belong to any of the groups.

Set Scene

1)Click "Menu" button to return to Menu select interface, click "Down" buttons to select "3. save Scene"



2)Click "Enter" button to enter save scene interface, we can configure total 16 scenes (Scene0-Scene15) to the device, click "Up" and "Down" buttons to select from Scene0-Scene15, then click "Enter" to enter scene configuration interface. Different colour types have different parameters, please refer to the detailed scene parameter setting for different colour types as follows:

Colour type	Scene setting
XY	<p>1)"Power" means the light intensity, "X coord" means X coordinate value, "Y coord" means Y coordinate value.</p> <p>2)First is to set intensity. Click "Enter" button to move the cursor to the 1st digit after "Power:", then click "Up" and "Down" button to select a digit, then click "Enter" to confirm and move the cursor to 2nd digit and set, then 3rd digit, once the power is set, click "Enter" button to confirm and the cursor will be moved to "Power:".</p> <p>3)Set XY coordinate value. After setting the intensity, click "Down" button to move the cursor to "X coord:" to set X coordinate value. Click "Enter" button to move the cursor to the 1st "F" after "X coord:", then click "Down" button to change it to 0.99, the cursor will be on 1st "9", then click "Down" to select a digit from 0-9 and click "Enter" to confirm and move the cursor to 2nd "9" and set, then click "Enter" to confirm setting and the cursor will be moved to "X coord:". Click "Down" button to move the cursor to</p>

XY	<p>"Y coord:" to set Y coordinate value.</p> <p>4)After setting Scene0, click "Enter" button to return to previous interface, then click "Down" button to select and set "Scene1" to "Scene15".</p> <p>Note:</p> <ul style="list-style-type: none"> Intensity settable value range: 000 (0%) -254 (100%) -255 (MASK), factory default is 255 (MASK), which means the device will retain its current intensity when relevant scene is recalled. XY coordinate settable value range: 0.01-0.99-FF, factory default is FF, which means RGB channels will retain their current XY coordinate values when relevant scene is recalled.
----	---

Tc	<p>1)"Power" means the light intensity and "TC" means the colour temperature.</p> <p>2)First is to set intensity. Click "Enter" button to move the cursor to the 1st digit after "Power:", then click "Up" and "Down" button to select a digit, then click "Enter" to confirm and move the cursor to 2nd digit and set, then 3rd digit, once the power is set, click "Enter" button to confirm and the cursor will be moved to "Power:".</p> <p>3)After setting the intensity, click "Down" button to move the cursor to "TC:" to set colour temperature. Click "Enter" button to move the cursor to the 1st "F" after "TC:", then click "Down" button to change the value to "10000K", the cursor will be on 1st digit "1", click "Up" and "Down" buttons to select a digit, then click "Enter" to confirm and move the cursor to 2nd digit and set, then 3rd, 4th and 5th, once the "TC" is set, click "Enter" button to confirm and the cursor will be moved to "TC:".</p> <p>4)After setting Scene0, click "Enter" button to return to previous interface, then click "Up" and "Down" button to select and set "Scene1" to "Scene15".</p> <p>Note:</p> <ul style="list-style-type: none"> Intensity settable value range: 000 (0%) -254 (100%) -255 (MASK), factory default is 255 (MASK), which means the device will retain its current intensity when relevant scene is recalled. Colour temperature settable value range: 01600K-10000K-FFFFFK, factory default is FFFFFK, which means the device will retain its current colour temperature when relevant scene is recalled.
----	--

RGBWA	<p>1)"Power" means the light intensity and "R, G, B, W" mean the value of each channel.</p> <p>2)First is to set intensity. Click "Enter" button to move the cursor to the 1st digit after</p>
-------	--

RGBWA	<p>"Power:", then click "Up" and "Down" button to select a digit, then click "Enter" to confirm and move the cursor to 2nd digit and set, then 3rd digit, once the power is set, click "Enter" button to confirm and the cursor will be moved to "Power:".</p> <p>3)After setting the intensity, click "Down" button to move the cursor to "R:" to set red colour value. Click "Enter" button to move the cursor to the 1st digit after "R:", then click "Up" and "Down" button to select a digit, then click "Enter" to confirm and move the cursor to 2nd digit and set, then 3rd, once the "R" is set, click "Enter" button to confirm and the cursor will be moved to "R:". Then click "Down" button to move the cursor to "G:" and set, then "B:", then "W:".</p> <p>4)After setting Scene0, click "Enter" button to return to previous interface, then click "Up" and "Down" button to select and set "Scene1" to "Scene15".</p> <p>Note:</p> <ul style="list-style-type: none"> • Light intensity settable value range: 000 (0%) -254 (100%) -255 (MASK), factory default is 255 (MASK), which means the device will retain its current intensity when relevant scene is recalled. • R, G, B, W value settable value range: 000 (0%) -255 (100%), factory default is 255 (100%). • Number of RGBWA channels can be set as 3/4/5 while choosing RGBWA colour. 3 means RGB, 4 means RGBW and 5 means RGBWA. Factory default is 4 channels RGBW.
--------------	--

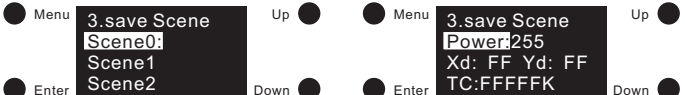
XY+Tc	 <p>1)"Power" means the light intensity, "Xd" means X coordinate value, "Yd" means Y coordinate value, and "TC" means colour temperature.</p> <p>2)First is to set intensity. Click "Enter" button to move the cursor to the 1st digit after "Power:", then click "Up" and "Down" button to select a digit, then click "Enter" to confirm and move the cursor to 2nd digit and set, then 3rd digit, once the power is set, click "Enter" button to confirm and the cursor will be moved to "Power:".</p> <p>3)Set XY coordinate value. After setting the intensity, click "Down" button to move the cursor to "Xd:" to set X coordinate value. Click "Enter" button to move the cursor to the 1st "F" after "Xd:", then click "Down" button to change it to 0.99, the cursor will be on 1st "9", then click "Down" to select a digit and click enter to confirm and move the cursor to 2nd "9" and select a digit, then click "Enter" to confirm setting and the cursor will be moved to "Xd:". Click "Down" button to move the cursor to "Yd:" to set Y coordinate value.</p> <p>4)Set colour temperature. After setting the XY coordinate value, click "Down" button to move the cursor to "TC:" to set colour temperature. Click "Enter" button to move the cursor to the 1st "F" after "TC:", then click "Down" button to change the value to "10000", the cursor will be on 1st digit "1", click "Down" button to select a digit, then click "Enter" to confirm and move the cursor to 2nd digit and set, then 3rd, 4th and 5th, once the "TC" is set, click "Enter" button to confirm and the cursor will be moved to "TC:".</p>
--------------	---

XY+Tc	<p>5)After setting Scene0, click "Enter" button to return to previous interface, then click "Up" and "Down" button to select and set "Scene1" to "Scene15".</p> <p>Note:</p> <ul style="list-style-type: none"> • Intensity settable value range: 000 (0%) -254 (100%) -255 (MASK), factory default is 255 (MASK), which means the device will retain its current intensity when relevant scene is recalled. • XY coordinate settable value range: 0.01-0.99-FF, factory default is FF, which means RGB channels will retain their current XY coordinate values when relevant scene is recalled. • Colour temperature settable value range: 01600K-10000K-FFFFFFK, factory default is FFFFFFFK, which means the device will retain its current colour temperature when relevant scene is recalled.
--------------	--

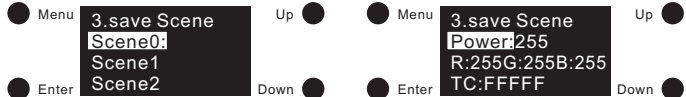
RGB+Tc	 <p>1)"Power" means the light intensity, "R, G, B" mean the value of RGB channels, and "TC" means colour temperature of tunable white channels.</p> <p>2)First is to set intensity. Click "Enter" button to move the cursor to the 1st digit after "Power:", then click "Up" and "Down" button to select a digit, then click "Enter" to confirm and move the cursor to 2nd digit and set, then 3rd digit, once the power is set, click "Enter" button to confirm and the cursor will be moved to "Power:".</p> <p>3)After setting the intensity, click "Down" button to move the cursor to "R:" to set red colour value. Click "Enter" button to move the cursor to the 1st digit after "R:", then click "Up" and "Down" button to select a digit, then click "Enter" to confirm and move the cursor to 2nd digit and set, then 3rd digit, once the "R" is set, click "Enter" button to confirm and the cursor will be moved to "R:". Then click "Down" button to move the cursor to "G:" and set, then "B:".</p> <p>4)Set colour temperature. After setting the RGB colour value, click "Down" button to move the cursor to "TC:" to set colour temperature. Click "Enter" button to move the cursor to the 1st "F" after "TC:", then click "Down" button to change the value to "10000", the cursor will be on 1st digit "1", click "Down" button to select a digit, then click "Enter" to confirm and move the cursor to 2nd digit and set, then 3rd, 4th and 5th, once the "TC" is set, click "Enter" button to confirm and the cursor will be moved to "TC:".</p> <p>5)After setting Scene0, click "Enter" button to return to previous interface, then click "Up" and "Down" button to select and set "Scene1" to "Scene15".</p> <p>Note:</p> <ul style="list-style-type: none"> • Intensity settable value range: 000 (0%) -254 (100%) -255 (MASK), factory default is 255 (MASK), which means the device will retain its current intensity when relevant scene is recalled. • R, G, B value settable value range: 000 (0%) -255 (100%), factory default is 255 (100%).
---------------	--

RGB+Tc	<ul style="list-style-type: none"> Colour temperature settable value range: 01600K-10000K-FFFFFK, factory default is FFFFFK, which means the device will retain its current colour temperature when relevant scene is recalled.
---------------	--

Go to Scene

1)Click "Menu" button to return to Menu select interface, click "Up" and "Down" buttons to select "4. go to Scene"

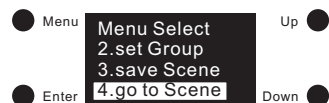

2)Click "Enter" button to enter get Scene interface, we can recall total 16 configured scenes (scene0-scene15):

3)Total 16 scenes can be recalled (Scene0 – Scene15), click "Up" and "Down" buttons to select from Scene0 to Scene15, then click "Enter" button to confirm and recall corresponding scene and the recalled scene details will be showed on the display.

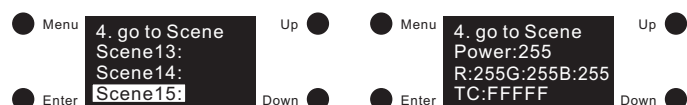

Set Out Level

1)This configuration is to set out level of the device manually. Click "Menu" button to return to Menu select interface, click "Up" and "Down" buttons to select "5. set Out level"

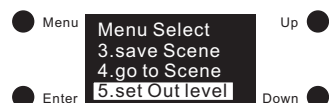

3)Click "Enter" button to enter set Out level interface, different colour types have different parameters, please refer to the detailed parameter setting for different colour types as follows:

Colour type	Out level setting
XY	<p>1)"Power" means the light intensity, "X coord" means X coordinate value, "Y coord" means Y coordinate value.</p> <p>2)First is to set intensity. Click "Enter" button to move the cursor to the 1st digit after "Power:", then click "Up" and "Down" button to select a digit, then click "Enter" to confirm and move the cursor to 2nd digit and set, then 3rd digit, once the power is set, click "Enter" button to confirm and the cursor will be moved to "Power:".</p>

XY	<p>3)Set XY coordinate value. After setting the intensity, click "Down" button to move the cursor to "X coord:" to set X coordinate value. Click "Enter" button to move the cursor to the 1st digit after "0.", then click "Up" and "Down" button to select a digit, then click "Enter" to confirm and move the cursor to the 2nd digit and click "Up" and "Down" button to select a digit and click "Enter" to confirm setting and the cursor will be moved to "X coord:". Click "Down" button to move the cursor to "Y coord:" to set Y coordinate value.</p> <p>Note:</p> <ul style="list-style-type: none"> Intensity settable value range: 000 (0%) -254 (100%), factory default is 254 (100%), which means the device will retain its current intensity when relevant scene is recalled. XY coordinate settable value range: 0.01-0.99, factory default is X=0.32, Y=0.32.
Tc	<p>1)"Power" means the light intensity and "TC" means the colour temperature.</p> <p>2)First is to set intensity. Click "Enter" button to move the cursor to the 1st digit after "Power:", then click "Up" and "Down" button to select a digit, then click "Enter" to confirm and move the cursor to 2nd digit and set, then 3rd digit, once the power is set, click "Enter" button to confirm and the cursor will be moved to "Power:".</p> <p>3)After setting the intensity, click "Down" button to move the cursor to "TC:" to set colour temperature. Click "Enter" button to move the cursor to the 1st digit after "TC:", then click "Up" and "Down" button to select a digit, then click "Enter" to confirm and move the cursor to 2nd digit and set, then 3rd, 4th and 5th, once the "TC" is set, click "Enter" button to confirm and the cursor will be moved to "TC:".</p> <p>Note:</p> <ul style="list-style-type: none"> Intensity settable value range: 000 (0%) -254 (100%), factory default is 254 (100%). Colour temperature settable value range: 01600K-10000K, factory default is 4098K.
RGBWA	<p>1)"Power" means the light intensity and "R, G, B, W" mean the value of each channel.</p> <p>2)First is to set intensity. Click "Enter" button to move the cursor to the 1st digit after "Power:", then click "Up" and "Down" button to select a digit, then click "Enter" to confirm and move the cursor to 2nd digit and set, then 3rd digit, once the power is set, click "Enter" button to confirm and the cursor will be moved to "Power:".</p> <p>3)After setting the intensity, click "Down" button to move the cursor to "R:" to set red colour value. Click "Enter" button to move the cursor to the 1st digit after "R:", then</p>

RGBWA	<p>click "Up" and "Down" button to select a digit, then click "Enter" to confirm and move the cursor to 2nd digit and set, then 3rd, once the "R" is set, click "Enter" button to confirm and the cursor will be moved to "R:". Then click "Down" button to move the cursor to "G:" and set, then "B:", then "W:".</p> <p>Note:</p> <ul style="list-style-type: none"> Intensity settable value range: 000 (0%) -254 (100%), factory default is 254 (100%). R, G, B, W value settable value range: 000 (0%) -255 (100%), factory default is 254 (99.6%). Number of RGBWA channels can be set as 3/4/5 while choosing RGBWA colour. 3 means RGB, 4 means RGBW and 5 means RGBWA. Factory default is 4 channels RGBW.
--------------	---

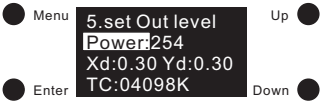
XY+Tc	 <p>1)"Power" means the light intensity, "Xd" means X coordinate value, "Yd" means Y coordinate value, and "TC" means colour temperature.</p> <p>2)First is to set intensity. Click "Enter" button to move the cursor to the 1st digit after "Power:", then click "Up" and "Down" button to select a digit, then click "Enter" to confirm and move the cursor to 2nd digit and set, then 3rd digit, once the power is set, click "Enter" button to confirm and the cursor will be moved to "Power:".</p> <p>3)Set XY coordinate value. After setting the intensity, click "Down" button to move the cursor to "Xd:" to set X coordinate value. Click "Enter" button to move the cursor to the 1st digit after "0.", then click "Up" and "Down" button to select a digit, then click "Enter" to confirm and move the cursor to the 2nd digit and select a digit, then click "Enter" to confirm setting and the cursor will be moved to "Xd:". Click "Down" button to move the cursor to "Yd:" to set Y coordinate value.</p> <p>4)Set colour temperature. After setting the XY coordinate value, click "Down" button to move the cursor to "TC:" to set colour temperature. Click "Enter" button to move the cursor to the 1st digit after "TC:", then click "Up" and "Down" button to select a digit, then click "Enter" to confirm and move the cursor to 2nd digit and set, then 3rd, 4th and 5th, once the "TC" is set, click "Enter" button to confirm and the cursor will be moved to "TC:".</p> <p>Note:</p> <ul style="list-style-type: none"> Intensity settable value range: 000 (0%) -254 (100%), factory default is 254 (100%), which means the device will retain its current intensity when relevant scene is recalled. XY coordinate settable value range: 0.01-0.99, factory default is X=0.30, Y=0.30. Colour temperature settable value range: 01600K-10000K, factory default is 4098K.
--------------	---

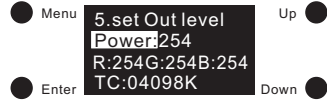
RGB+Tc	 <p>1)"Power" means the light intensity, "R, G, B" mean the value of RGB channels, and "TC" means colour temperature of tunable white channels.</p> <p>2)First is to set intensity. Click "Enter" button to move the cursor to the 1st digit after "Power:", then click "Up" and "Down" button to select a digit, then click "Enter" to confirm and move the cursor to 2nd digit and set, then 3rd digit, once the power is set, click "Enter" button to confirm and the cursor will be moved to "Power:".</p> <p>3)After setting the intensity, click "Down" button to move the cursor to "R:" to set red colour value. Click "Enter" button to move the cursor to the 1st digit after "R:", then click "Up" and "Down" button to select a digit, then click "Enter" to confirm and move the cursor to 2nd digit and set, then 3rd, once the "R" is set, click "Enter" button to confirm and the cursor will be moved to "R:". Then click "Down" button to move the cursor to "G:" and set, then "B:".</p> <p>4)Set colour temperature. After setting the RGB colour value, click "Down" button to move the cursor to "TC:" to set colour temperature. Click "Enter" button to move the cursor to the 1st digit after "TC:", then click "Up" and "Down" button to select a digit, then click "Enter" to confirm and move the cursor to 2nd digit and select a digit, then 3rd, 4th and 5th, once the "TC" is set, click "Enter" button to confirm and the cursor will be moved to "TC:".</p> <p>Note:</p> <ul style="list-style-type: none"> Intensity settable value range: 000 (0%) -254 (100%), factory default is 254 (100%). R, G, B value settable value range: 000 (0%) -255 (100%), factory default is 254 (99.6%). Colour temperature settable value range: 01600K-10000K, factory default is 4098K.
---------------	--

Set PWM freq

1)This configuration is to set PWM output frequency. Click "Menu" button to return to Menu select interface, click "Up" and "Down" buttons to select "13. set PWM freq"

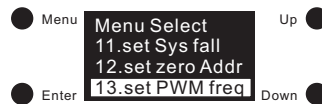

2)Click "Enter" button to enter set PWM frequency interface, then click "Enter" button to move the cursor to the digit "0" after "freq:", click "Up" and "Down" to select from 00-11 (250Hz-30KHz), then click "Enter" to confirm setting and the cursor will move to "freq:". Detailed PWM frequency setting are as follows:

Number	00	01	02	03	04	05	06	07	08	09	10	11
Frequency	250Hz	500Hz	1KHz	2KHz	3KHz	4KHz	5KHz	10KHz	15KHz	20KHz	25KHz	30KHz

3)“Mode” is for setting dimming mode. Two modes are selectable: positive dimming and negative dimming. Click “down” button to move the cursor to “mode”, then click “enter” button to move the cursor to “0” after “mode” and then “Up” and “Down” to select “0/1”, then click “Enter” button to confirm.

0 is positive dimming and under this mode when DALI value changes from 000 to 254, the light intensity will go from 0% to 100%.

1 is negative dimming and under this mode when DALI value changes from 000 to 254, the light intensity will go from 100% to 0%.

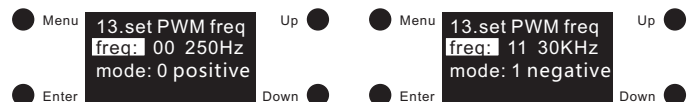

Note:

- By factory default, the PWM output frequency is 00 (250Hz).
- By factory default, the dimming mode is 0 positive dimming.

Set wm cl ph (for colour types Tc, XY+Tc and RGB+Tc only)

This configuration is to set a physical lower limit and a physical upper limit for colour temperature of the device.

1)Once set colour type as Tc, XY+Tc or RGB+Tc, click “Menu” button to return to Menu select interface, click “Up” and “Down” buttons to select “11. set wm cl ph”.

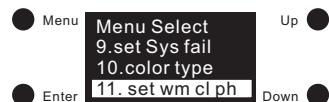

2)Click “Enter” button to enter set wm cl ph interface, “ph warm” is to set the physical lower limit for colour temperature and “ph cool” is to set the physical upper limit.

3)Click “Enter” button to move the cursor to the 1st digit after “ph warm:”, click “Up” and “Down” to select a digit, then click “Enter” to confirm and move the cursor to 2nd digit and set, then 3rd, 4th and 5th, once the “ph warm:” is set, click “Enter” button to confirm and the cursor will be moved to “ph warm:”. Then click “Down” button to move the cursor to “ph cool” and set.

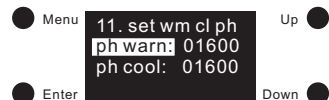

Note:

- The physical lower and upper limits for the colour temperature settable value range: 01600-10000.
- Factory default value for Tc colour type: “ph warm” is 2702, “ph cool” is 6493.
- Factory default value for XY+Tc colour type: “ph warm” is 6493, “ph cool” is 10000.
- Factory default value for RGB+Tc colour type: “ph warm” is 3003, “ph cool” is 3003.

Set wm cl tc (for colour types Tc, XY+Tc and RGB+Tc only)

This configuration is to set colour temperature range in which the colour temperature of the device can be changed.

1)Once set colour type as Tc, XY+Tc or RGB+Tc, click “Menu” button to return to Menu select interface, click “Up” and “Down” buttons to select “12. set wm cl tc”.

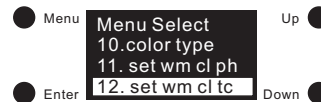

2)Click “Enter” button to enter set wm cl tc interface, “warmest” is to set the warmest colour temperature and “coolest” is to set the coolest colour temperature.

3)Click “Enter” button to move the cursor to the 1st digit after “warmest:”, click “Up” and “Down” to select a digit, then click “Enter” to confirm and move the cursor to 2nd digit and set, then 3rd, 4th and 5th, once the “warmest” is set, click “Enter” button to confirm and the cursor will be moved to “warmest:”. Then click “Down” button to move the cursor to “coolest” and set.

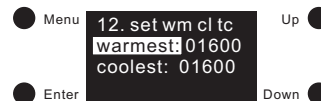

Note:

- The colour temperature settable value range: 01600-10000. The value of warmest can not be lower than the physical lower limit, and the value of coolest can not be higher than the physical upper limit. The coolest value must be bigger than the warmest value.
- Factory default value for Tc colour type: “warmest” is 2702, “coolest” is 6493.
- Factory default value for XY+Tc colour type: “warmest” is 6493, “coolest” is 10000.
- Factory default value for RGB+Tc colour type: “warmest” is 3003, “coolest” is 3003.

Setting DALI default parameters

The following DALI default parameters can be set:

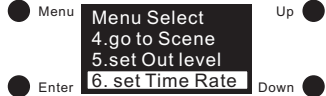
DALI default parameters	Description
Fade time	<p>1)Click “Menu” button to return to Menu select interface, click “Up” and “Down” buttons to select “6. set Time Rate”</p>  <p>2)Click “Enter” button to enter set Fade time and Fade rate interface, then click “Enter” button to move the cursor to the 1st digit after “Fade time:”, click “Up” and “Down” to select a digit, then click “Enter” to confirm setting and move the cursor to 2nd digit and set, then click “Enter” to confirm and the cursor will be moved to “Fade time:”.</p>

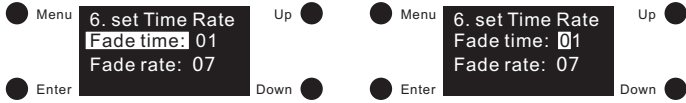
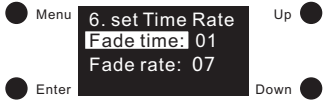
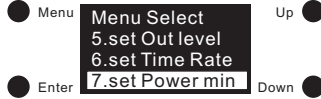
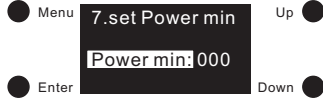
<p>Fade time</p>	 <p>3)The selected value is set as the fade time in seconds. Value range: • 00–15 s</p> <p>Note: 00 s is the DALI default. 00 s is the fastest fade time, and 15 s is the slowest.</p>
<p>Fade rate</p>	<p>1)On set Time Rate interface, after setting the Fade time, click “Down” button to move the cursor to “Fade rate:”, then click “Enter” button to move the cursor to the 1st digit after “Fade rate:”, click “Up” and “Down” to select a digit, then click “Enter” to confirm and move the cursor to 2nd digit and set, then click “Enter” to confirm and the cursor will be moved to “Fade rate:”</p>  <p>2)The selected value is set as the dimming speed. It indicates by how many steps per second the intensity is changed. The Fade Rate is used with the DALI commands Brighten (Up) and Dim (Down). Value range: • 01–15 steps per second</p> <p>Note: 07 steps per second is the DALI default. 15 steps per second is the fastest fade rate, and 01 steps per second is the slowest.</p>
<p>Minimum level</p>	<p>1)Click “Menu” button to return to Menu select interface, click “Up” and “Down” buttons to select “7. set Power min”</p>  <p>2)Click “Enter” button to enter set Minimum level interface, click “Enter” to move the cursor to the 1st digit after “Power min:”, click “Up” and “Down” to select a digit, then click “Enter” to confirm and move the cursor to 2nd digit and set, then 3rd digit, then click “Enter” button to move the cursor to “Power min:” and confirm setting.</p>  <p>3)The selected value is set as the minimum level for the control gear. This value cannot be fallen below during dimming/brightening. Value range: • 000 (0%)-250 (98.4%)</p> <p>Note: 000 (0%) is the factory default minimum level.</p>

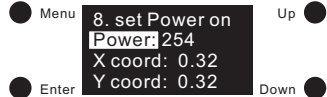
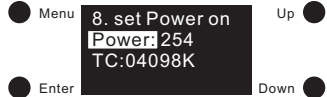
<p>Power On Level</p>	<p>1)Click “Menu” button to return to Menu select interface, click “Up” and “Down” buttons to select “8. set Power on”</p>  <p>2)Click “Enter” button to enter set power on level interface, different colour types have different parameters to be set. The selected values are set as the values after power is restored. Power on level setting instructions for different colour types are as follows:</p> <p>Set XY Colour Power On</p>  <p>1)“Power” means the light intensity, “X coord” means X coordinate value, “Y coord” means Y coordinate value. 2)First is to set intensity. Click “Enter” button to move the cursor to the 1st digit after “Power:”, then click “Up” and “Down” button to select a digit, then click “Enter” to confirm and move the cursor to 2nd digit and set, then 3rd digit, once the power is set, click “Enter” button to confirm and the cursor will be moved to “Power:”. 3)Set XY coordinate value. After setting the intensity, click “Down” button to move the cursor to “X coord:” to set X coordinate value. Click “Enter” button to move the cursor to the 1st digit after “0.”, then click “Up” and “Down” button to select a digit, then click “Enter” to confirm and move the cursor to the 2nd digit and set, then click “Enter” to confirm setting and the cursor will be moved to “X coord:”. Click “Down” button to move the cursor to “Y coord:” to set Y coordinate value.</p> <p>Note:</p> <ul style="list-style-type: none"> • Intensity settable value range: 000 (0%) -254 (100%), factory default is 254 (100%). • XY coordinate settable value range: 0.01-0.99, factory default is X=0.32, Y=0.32. <p>Set Tc Colour Power On</p>  <p>1)“Power” means the light intensity and “TC” means the colour temperature. 2)First is to set intensity. Click “Enter” button to move the cursor to the 1st digit after “Power:”, then click “Up” and “Down” button to select a digit, then click “Enter” to confirm and move the cursor to 2nd digit and set, then 3rd digit, once the power is set, click “Enter” button to confirm and the cursor will be moved to “Power:”. 3)After setting the intensity, click “Down” button to move the cursor to “TC:” to set colour temperature. Click “Enter” button to move the cursor to the 1st digit after “TC:”, then click “Up” and “Down” button to select a digit, then click “Enter” to confirm and move the cursor to 2nd digit and set, then 3rd, 4th and 5th, once the “TC” is set, click “Enter” button to confirm and the cursor will be moved to “TC:”.</p>
------------------------------	--

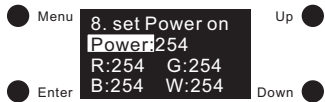
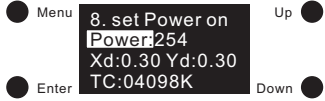
Power On Level	<p>Note:</p> <ul style="list-style-type: none"> Intensity settable value range: 000 (0%) -254 (100%), factory default is 254 (100%). Colour temperature settable value range: 01600K-10000K, factory default is 4098K. <p>Set RGBWA Colour Power On</p>  <p>1)"Power" means the light intensity and "R, G, B, W" mean the value of each channel. 2)First is to set intensity. Click "Enter" button to move the cursor to the 1st digit after "Power:", then click "Up" and "Down" button to select a digit, then click "Enter" to confirm and move the cursor to 2nd digit and set, then 3rd digit, once the power is set, click "Enter" button to confirm and the cursor will be moved to "Power:". 3)After setting the intensity, click "Down" button to move the cursor to "R:" to set red colour value. Click "Enter" button to move the cursor to the 1st digit after "R:", then click "Up" and "Down" button to select a digit, then click "Enter" to confirm and move the cursor to 2nd digit and set, then 3rd, once the "R" is set, click "Enter" button to confirm and the cursor will be moved to "R:". Then click "Down" button to move the cursor to "G:" and set, then "B:", then "W:".</p> <p>Note:</p> <ul style="list-style-type: none"> Intensity settable value range: 000 (0%) -254 (100%), factory default is 254 (100%). R, G, B, W value settable value range: 000 (0%) -255 (100%), factory default is 254 (99.6%). Number of RGBWA channels can be set as 3/4/5 while choosing RGBWA colour. 3 means RGB, 4 means RGBW and 5 means RGBW+Amber. Factory default is 4 channels RGBW. <p>Set XY+TC Colour Power On</p>  <p>1)"Power" means the light intensity, "Xd" means X coordinate value, "Yd" means Y coordinate value, and "TC" means colour temperature. 2)First is to set intensity. Click "Enter" button to move the cursor to the 1st digit after "Power:", then click "Up" and "Down" button to select a digit, then click "Enter" to confirm and move the cursor to 2nd digit and set, then 3rd digit, once the power is set, click "Enter" button to confirm and the cursor will be moved to "Power:". 3)Set XY coordinate value. After setting the intensity, click "Down" button to move the cursor to "Xd:" to set X coordinate value. Click "Enter" button to move the cursor to the 1st digit after "0.", then click "Up" and "Down" button to select a digit, then click "Enter" to confirm and move the cursor to the 2nd digit and set, then click "Enter" to confirm setting and the cursor will be moved to "Xd:". Click "Down" button to move the cursor to "Yd:" to set Y coordinate value. 4)Set colour temperature. After setting the XY coordinate value, click "Down" button to move the cursor to "TC:" to set colour temperature. Click "Enter" button to move the cursor to the 1st digit after "TC:", then click "Up" and "Down" button to select a digit,</p>

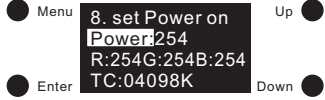
Power On Level	<p>then click "Enter" to confirm and move the cursor to 2nd digit and set, then 3rd, 4th and 5th, once the "TC" is set, click "Enter" button to confirm and the cursor will be moved to "TC:".</p> <p>Note:</p> <ul style="list-style-type: none"> Intensity settable value range: 000 (0%) -254 (100%), factory default is 254 (100%). XY coordinate settable value range: 0.01-0.99, factory default is X=0.30, Y=0.30. Colour temperature settable value range: 01600K-10000K, factory default is 4098K. <p>Set RGB+Tc Colour Power On</p>  <p>1)"Power" means the light intensity, "R, G, B" mean the value of RGB channels, and "TC" means colour temperature of tunable white channels. 2)First is to set intensity. Click "Enter" button to move the cursor to the 1st digit after "Power:", then click "Up" and "Down" button to select a digit, then click "Enter" to confirm and move the cursor to 2nd digit and set, then 3rd digit, once the power is set, click "Enter" button to confirm and the cursor will be moved to "Power:". 3)After setting the intensity, click "Down" button to move the cursor to "R:" to set red colour value. Click "Enter" button to move the cursor to the 1st digit after "R:", then click "Up" and "Down" button to select a digit, then click "Enter" to confirm and move the cursor to 2nd digit and set, then 3rd, once the "R" is set, click "Enter" button to confirm and the cursor will be moved to "R:". Then click "Down" button to move the cursor to "G:" and set, then "B:". 4)Set colour temperature. After setting the RGB colour value, click "Down" button to move the cursor to "TC:" to set colour temperature. Click "Enter" button to move the cursor to the 1st digit after "TC:", then click "Up" and "Down" button to select a digit, then click "Enter" to confirm and move the cursor to 2nd digit and set, then 3rd, 4th and 5th, once the "TC" is set, click "Enter" button to confirm and the cursor will be moved to "TC:".</p> <p>Note:</p> <ul style="list-style-type: none"> Intensity settable value range: 000 (0%) -254 (100%), factory default is 254 (100%). R, G, B value settable value range: 000 (0%) -255 (100%), factory default is 254 (99.6%). Colour temperature settable value range: 01600K-10000K, factory default is 4098K.
	System Failure Level

System Failure Level

Set XY Colour System Failure

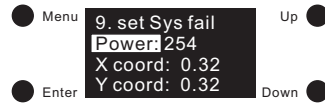

- 1) "Power" means the light intensity, "X coord" means X coordinate value, "Y coord" means Y coordinate value.
- 2) First is to set intensity. Click "Enter" button to move the cursor to the 1st digit after "Power:", then click "Up" and "Down" button to select a digit, then click "Enter" to confirm and move the cursor to 2nd digit and set, then 3rd digit, once the power is set, click "Enter" button to confirm and the cursor will be moved to "Power:".
- 3) Set XY coordinate value. After setting the intensity, click "Down" button to move the cursor to "X coord:" to set X coordinate value. Click "Enter" button to move the cursor to the 1st digit after "0.", then click "Up" and "Down" button to select a digit, then click "Enter" to confirm and move the cursor to the 2nd digit and set, then click "Enter" to confirm setting and the cursor will be moved to "X coord:". Click "Down" button to move the cursor to "Y coord:" to set Y coordinate value.

Note:

- Intensity settable value range: 000 (0%) -254 (100%), factory default is 254 (100%).
- XY coordinate settable value range: 0.01-0.99, factory default is X=0.32, Y=0.32.

Set Tc Colour System Failure

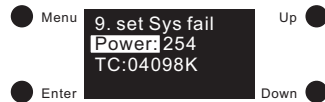

- 1) "Power" means the light intensity and "TC" means the colour temperature.
- 2) First is to set intensity. Click "Enter" button to move the cursor to the 1st digit after "Power:", then click "Up" and "Down" button to select a digit, then click "Enter" to confirm and move the cursor to 2nd digit and set, then 3rd digit, once the power is set, click "Enter" button to confirm and the cursor will be moved to "Power:".
- 3) After setting the intensity, click "Down" button to move the cursor to "TC:" to set colour temperature. Click "Enter" button to move the cursor to the 1st digit after "TC:", then click "Up" and "Down" button to select a digit, then click "Enter" to confirm and move the cursor to 2nd digit and set, then 3rd, 4th and 5th, once the "TC" is set, click "Enter" button to confirm and the cursor will be moved to "TC:".

Note:

- Intensity settable value range: 000 (0%) -254 (100%), factory default is 254 (100%).
- Colour temperature settable value range: 01600K-10000K, factory default is 4098K.

Set RGBWA Colour System Failure

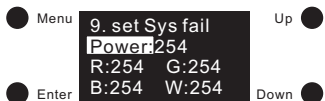

- 1) "Power" means the light intensity and "R, G, B, W" mean the value of each channel.
- 2) First is to set intensity. Click "Enter" button to move the cursor to the 1st digit after

System Failure Level

"Power:", then click "Up" and "Down" button to select a digit, then click "Enter" to confirm and move the cursor to 2nd digit and set, then 3rd digit, once the power is set, click "Enter" button to confirm and the cursor will be moved to "Power:".

3) After setting the intensity, click "Down" button to move the cursor to "R:" to set red colour value. Click "Enter" button to move the cursor to the 1st digit after "R:", then click "Up" and "Down" button to select a digit, then click "Enter" to confirm and move the cursor to 2nd digit and set, then 3rd, once the "R" is set, click "Enter" button to confirm and the cursor will be moved to "R:". Then click "Down" button to move the cursor to "G:" and set, then "B:", then "W:".

Note:

- Intensity settable value range: 000 (0%) -254 (100%), factory default is 254 (100%).
- R, G, B, W value settable value range: 000 (0%) -255 (100%), factory default is 254 (99.6%).
- Number of RGBWA channels can be set as 3/4/5 while choosing RGBWA colour. 3 means RGB, 4 means RGBW and 5 means RGBWA. Factory default is 4 channels RGBW.

Set XY+TC Colour System Failure

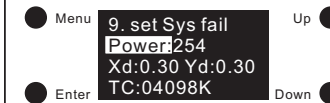

- 1) "Power" means the light intensity, "Xd" means X coordinate value, "Yd" means Y coordinate value, and "TC" means colour temperature.
- 2) First is to set intensity. Click "Enter" button to move the cursor to the 1st digit after "Power:", then click "Up" and "Down" button to select a digit, then click "Enter" to confirm and move the cursor to 2nd digit and set, then 3rd digit, once the power is set, click "Enter" button to confirm and the cursor will be moved to "Power:".
- 3) Set XY coordinate value. After setting the intensity, click "Down" button to move the cursor to "Xd:" to set X coordinate value. Click "Enter" button to move the cursor to the 1st digit after "0.", then click "Up" and "Down" button to select a digit, then click "Enter" to confirm and move the cursor to the 2nd digit and set, then click "Enter" to confirm setting and the cursor will be moved to "Xd:". Click "Down" button to move the cursor to "Yd:" to set Y coordinate value.
- 4) Set colour temperature. After setting the XY coordinate value, click "Down" button to move the cursor to "TC:" to set colour temperature. Click "Enter" button to move the cursor to the 1st digit after "TC:", then click "Up" and "Down" button to select a digit, then click "Enter" to confirm and move the cursor to 2nd digit and set, then 3rd, 4th and 5th, once the "TC" is set, click "Enter" button to confirm and the cursor will be moved to "TC:".

Note:

- Intensity settable value range: 000 (0%) -254 (100%), factory default is 254 (100%).
- XY coordinate settable value range: 0.01-0.99, factory default is X=0.30, Y=0.30.
- Colour temperature settable value range: 01600K-10000K, factory default is 4098K.

Set RGB+Tc Colour System Failure

System Failure Level

● Menu 9.set Sys fail Power:254 Up ●
 ● Enter R:254G:254B:254 TC:04098K Down ●

- 1)"Power" means the light intensity, "R, G, B" mean the value of RGB channels, and "TC" means colour temperature of tunable white channels.
- 2)First is to set intensity. Click "Enter" button to move the cursor to the 1st digit after "Power:", then click "Up" and "Down" button to select a digit, then click "Enter" to confirm and move the cursor to 2nd digit and set, then 3rd digit, once the power is set, click "Enter" button to confirm and the cursor will be moved to "Power:".
- 3)After setting the intensity, click "Down" button to move the cursor to "R:" to set red colour value. Click "Enter" button to move the cursor to the 1st digit after "R:", then click "Up" and "Down" button to select a digit, then click "Enter" to confirm and move the cursor to 2nd digit and set, then 3rd, once the "R" is set, click "Enter" button to confirm and the cursor will be moved to "G:" and set, then "B:".
- 4)Set colour temperature. After setting the RGB colour value, click "Down" button to move the cursor to "TC:" to set colour temperature. Click "Enter" button to move the cursor to the 1st digit after "TC:", then click "Up" and "Down" button to select a digit, then click "Enter" to confirm and move the cursor to 2nd digit and set, then 3rd, 4th and 5th, once the "TC" is set, click "Enter" button to confirm and the cursor will be moved to "TC:".

Note:

- Intensity settable value range: 000 (0%) -254 (100%), factory default is 254 (100%).
- R, G, B value settable value range: 000 (0%) -255 (100%), factory default is 254 (99.6%).
- Colour temperature settable value range: 01600K-10000K, factory default is 4098K.

Reset

- 1)This setting is to factory reset the device. Click "Menu" button to return to Menu select interface, click "Up" and "Down" buttons to select "Reset"

● Menu Menu Select 13.set zero Addr 14.set PWM freq 15.Reset Up ●
 ● Enter Down ●

- 2)Click "Enter" button to enter factory reset interface, click "Up" and "Down" button to move the cursor from "Abort" to "OK", "Abort" means cancelling the reset, "OK" means confirming the reset, then click "Enter" button to confirm the reset, then the display will flash "Restoring to default setting" and restart which means the reset is successful.

● Menu Resume to default setting? Up ●
 ● Enter Abort OK Down ●
 ● Menu Resume to default setting? Up ●
 ● Enter Down ●

Wiring Diagram

